



## Special-Purpose Performance in a General-Purpose 50 KC-65 MC Signal Generator

**T**O make available in a low-rf to vhf range signal generator the precision and convenience that the present state of the art permits, a new 50-kilocycle to 65-megacycle a-m signal generator having significantly enhanced performance characteristics has been developed. The enhancement extends to all three of the areas (carrier, modulation and output control)

SEE ALSO:  
 Friis becomes  
 consultant, p. 6  
 Gaither joins -hp-  
 B of D, p. 6

that define and classify a signal generator. Modulation characteristics, for example, are such as to permit modulation by square waves and other complex waves as well as by dc levels, a facility that can be used for remote programming and on-off or tone burst modulation. Envelope distortion is small enough and modulation bandwidth wide enough that for the first time it is

practical to check the harmonic distortion and bandwidth of high-fidelity a-m receivers on an overall basis by applying the signal to be measured through the receiver antenna terminal.

Rf-wise, the generator's carrier frequency has been carried high enough to include all of the major i-f bands including the 60-megacycle band, while high accuracy in selecting the carrier is facilitated by a two-frequency crystal calibrator. For such work as checking lines and driving antennas and bridges, the instrument has been given a high rf output of 3 volts across 50 ohms or 6 volts open circuit. It also has the property of maintaining essentially constant any modulation level and any rf output level over the full rf range. Other conveniences include the ability to achieve 100% modulation, a virtually constant output impedance, and the

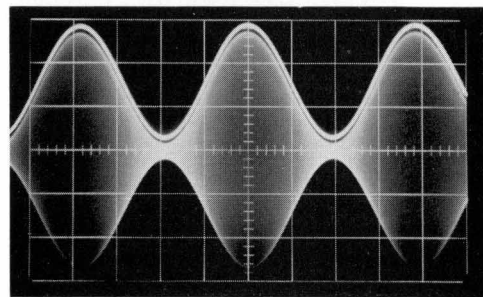

Fig. 2. Oscillogram of dual-trace scope presentation comparing modulated output from new generator with internal 1 kc modulating waveform (positioned closely above rf envelope). Envelope distortion is below 1%.

Fig. 1. (at left). New -hp- Model 606A 50 kc-65 mc Signal Generator has been designed with wide modulation bandwidth and low modulation distortion to meet present-day circuit test needs. Carrier range covers major i-f bands including 60 mc band. Modulation bandwidth extends to dc, permitting unit to be remotely programmed.

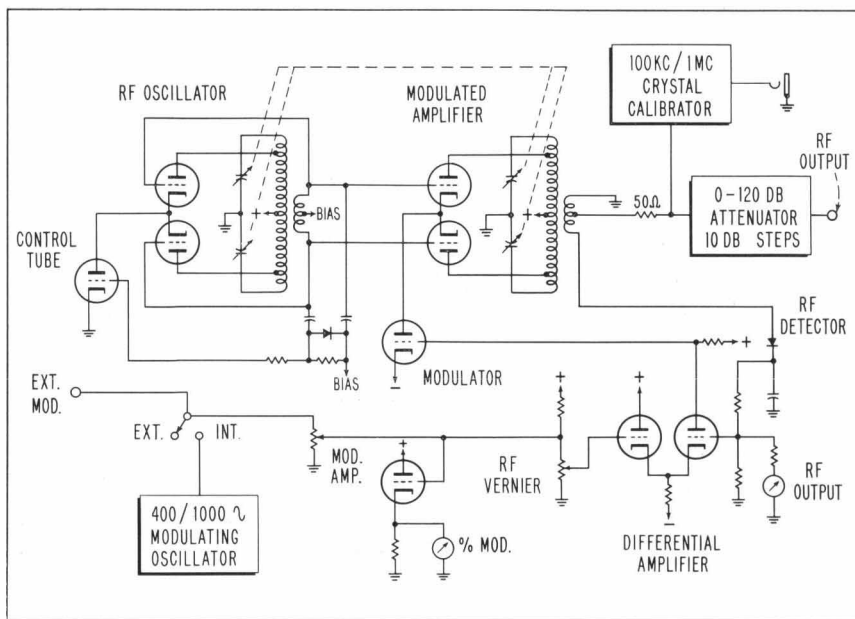

Fig. 3. Basic circuit arrangement of hp Model 606A Signal Generator.

availability of a standard dummy antenna.

#### CIRCUITRY

Circuitwise, the new generator has the form indicated in Fig. 3. The rf oscillator covers the 50 kc - 65 mc range in 6 bands, each having a frequency span of about 3.4:1. The bands are arranged so that the standard broadcast range (535-1605 kc) is covered in a single band, the actual coverage of the band being from 530 to 1800 kc.

#### Band Coverage

50 — 170 kc
165 — 560 kc
530 — 1800 kc
1.76 — 6.0 mc
5.8 — 19.2 mc
19.0 — 65.0 mc

As a basic approach toward achieving low harmonic content and relatively high power output, the oscillator uses a push-pull configuration. To further maintain harmonics at a low value, the oscillator is operated with its cathode currents controlled in such a way that oscillation peaks are limited by the current available to the oscillator tubes rather than by grid or plate limiting therein. The current control consists of a tube in series with the oscillator cathodes to limit cathode current to a suitable value. Grid bias is also fixed, so that the oscillator tubes are never allowed to draw grid current with attendant grid heating and frequency instability. The oscillator is thus operated as a class B

circuit, a circuit inherently higher in stability than class C circuits.

The taps indicated in Fig. 3 on the oscillator tank coil are arranged to achieve a reduced variation in load impedance for the tubes as tuning ranges are changed. This is supplemented by an arrangement that applies a sample of oscillator output level in dc form back to the current control tube. The current available to the oscillator tubes is thus controlled in such a way as to compensate to within about 1 db for the output changes that would otherwise occur as the oscillator was tuned and ranges changed.

The oscillator coils themselves, except for those on the highest-frequency band, are tension-wound on ceramic forms having low temperature-coefficients of expansion for stability considerations. The highest frequency inductor, which is air-cored, is formed from invar for the same reasons. Similarly, the tuning-capacitor materials have been selected so that temperature effects will be largely self-compensating and have very little effect on capacitance. The capacitors themselves are gold-plated for low loss and chemical stability considerations.

#### DIAL DRIVE

The tuning capacitors are driven through a 18:1 reduction spring-loaded gear drive which operates in combination with a 100-division panel vernier. This drive provides a mechanical resolution for each band of about 1 part in 1600, which in combination with the crystal calibrator permits any desired

output frequency to be selected to high accuracy. For restricted-range work, the cursor on the tuning dial is arranged with a mechanical vernier which can be set in combination with the crystal calibrator.

#### RF AMPLIFIER

Like the oscillator, the rf amplifier has a push-pull configuration which is operated class B for the same considerations of high output, high efficiency, low harmonic generation, and high stability. Grid bias is again fixed, while current available to the cathodes is controlled by a series tube to avoid limiting by tube non-linearities. In the case of the amplifier, however, the tube that controls current also serves as a modulator, the modulating signal being impressed on its grid through intervening circuitry described later.

The amplifier also has the unusual arrangement of operating within a feedback loop that accomplishes the three purposes of stabilizing the rf output level as a function of frequency, maintaining percentage modulation constant with frequency and increasing the fidelity of modulation to a high level.

The feedback voltage is derived from the amplifier output and applied to a detector which provides both a dc and an ac output. The dc output is proportional to the carrier level, while the ac output is the recovered modulation envelope. The dc current is then applied to the output level meter for a direct measure of output level, while both the dc and ac levels are applied to one input of a differential amplifier. The other input of this amplifier receives the signal to be impressed on the carrier as modulation. The differential amplifier output thus consists of a dc level proportional to the carrier level and a signal which is the difference between the applied modulating waveform and the recovered envelope. These two components are then applied to the grid of the tube that controls the cathode current available to the rf amplifier. Since the amplifier output is proportional to the current available to the tank circuit, the rf output will be modulated by the waveform of current made available by the control tube, while the carrier level will be proportional to the dc component from the control tube. The arrangement thus largely compensates for distortion produced in the modulation process. At the same time the dc feedback maintains carrier output constant, and the ac feedback maintains a constant percentage modulation in accordance with the amplitude of the original

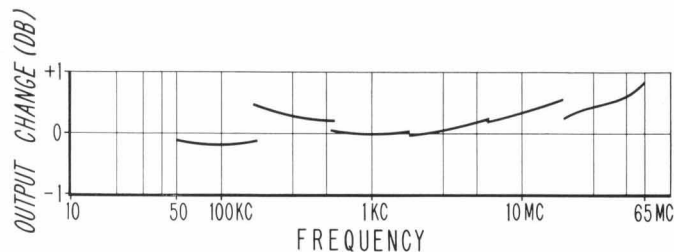

Fig. 4. Use of circuit measures described in text makes generator's rf output level essentially constant over complete frequency range, as indicated in typical response shown above.

modulating wave-form. The amount of dc and low-frequency feedback provided by the loop varies from 30 to 40 db depending on carrier frequency.

The practical effect of the amplifier and modulator design is shown in Figs. 4 and 5. First, Fig. 4 shows that for a given setting of the output controls the variation in output level over the full frequency range of the generator is less than 1 db. Secondly, Fig. 5 shows that modulation percentage under similar conditions is constant within a few percent. While it is rare in actual practice that this constancy of output and modulation will be called on over such a wide frequency range, its presence does mean that almost no precautions must be exercised in these respects for typical situations such as checking the selectivity of receivers and the responses of amplifiers, filters, etc.

#### INCIDENTAL F-M AND A-M

Operating the rf amplifier as a push-pull circuit makes it convenient to use conventional cross-neutralization techniques to minimize variations in amplifier input capacitance and thus to keep more constant the load presented to the oscillator. This step, together with loose coupling and other measures, keeps incidental f-m in the carrier to a very low value so that high-slope circuits can be satisfactorily tested without significant response from spurious f-m in the carrier. For modulation level of 30% and an output level of 1 volt or less, incidental f-m is rated as being less than 25 cycles per megacycle of carrier frequency or 100 cps, whichever is larger.

Spurious a-m is also extremely low. Hum and noise sideband levels are 70 db below the carrier level until the thermal level of the 50-ohm output system is reached.

#### MODULATION CIRCUITRY

Modulation provisions incorporated in the generator include both an internal 400/1000 cps sine-wave modulation oscillator as well as provision for modulation by external voltages lying anywhere in the range from dc to above 20 kc. The internal modulating oscillator is an RC type with very low distortion, typically below 0.3%. When internal modulation is being used, the modulating waveform is available for external use at the "Modulation" input terminal, a feature often convenient for triggering an oscilloscope to view the modulated waveform after it has passed through a circuit under test.

A comparison of the 1 kc waveform from the internal oscillator together with the resulting modulated output for a carrier frequency of 1 megacycle is shown in Fig. 2 (front page). The modulating waveform has been positioned closely above the resulting rf waveform to facilitate comparison. Actually, envelope distortion is too small to be detected visually, being less than 1% here for a modulation depth of 88%. Although envelope distortion is not rated for modulation levels higher than 70%, Fig. 2 shows typical performance at a higher level.

The fidelity of modulation is achieved by use of the feedback arrangement discussed earlier wherein the detected rf output envelope is compared with the modulating waveform in a differential

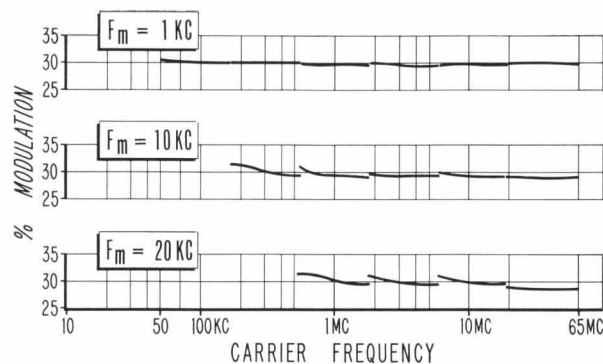

Fig. 5. Typical constancy of modulation as a function of rf output frequency for a given setting of modulation amplitude controls.

amplifier and the difference waveform used for modulating purposes. Quantitative information on the effectiveness of this arrangement is given in Fig. 7. Fig. 7 (a) shows modulation distortion as a function of a modulation percentage at a carrier frequency of 455 kc, the usual i-f frequency in standard broadcast receivers. It can be seen that for the standard test modulation percentage of 30% the envelope distortion even at a modulating frequency of 20 kc is typically below 1%. The data have been carried beyond ratings (dashed lines) to show typical performance in these regions, although beyond-rating performance is not controlled.

Similar data, but for carrier frequencies of 1 and 30 megacycles, are shown in Figs. 7 (b) and (c).

#### SQUARE-WAVE AND PULSE MODULATION

In order to provide maximum convenience in the generator for testing present-day systems and circuitry, the bandwidth of the modulation circuits has been designed to extend from dc to 20 kc with a slow roll-off thereafter. This enables the generator to be pulse- and square wave-modulated from external sources for applications such as examining the transient and pulse response of devices incorporating video and audio amplifiers. Typical square-wave characteristics for the generator are shown in Figs. 8 (a, b) for the band

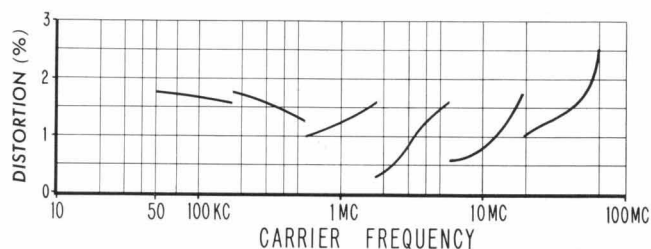

Fig. 6. Typical harmonic content of Model 606A carrier.

incorporating the standard broadcast range using a 1 kc square wave. A slight over-shoot may occur, as in Fig. 8 (b), at some parts of the band, but it is normally less than 5%. The on-off ratio is greater than 40 db, although trace thickening in the oscillogram due to the

large change in writing rate between the rf pattern and the off interval makes the ratio appear less favorable.

Fig. 9 shows square-wave modulation on the highest band of the generator at a carrier of 60 megacycles. Here, a detector was used on the rf output so that

this oscillogram compares the modulating waveform with the demodulated carrier.

The rise-time and pulse characteristics of the generator are illustrated by Fig. 10. In this oscillogram the carrier frequency is 60 megacycles and the

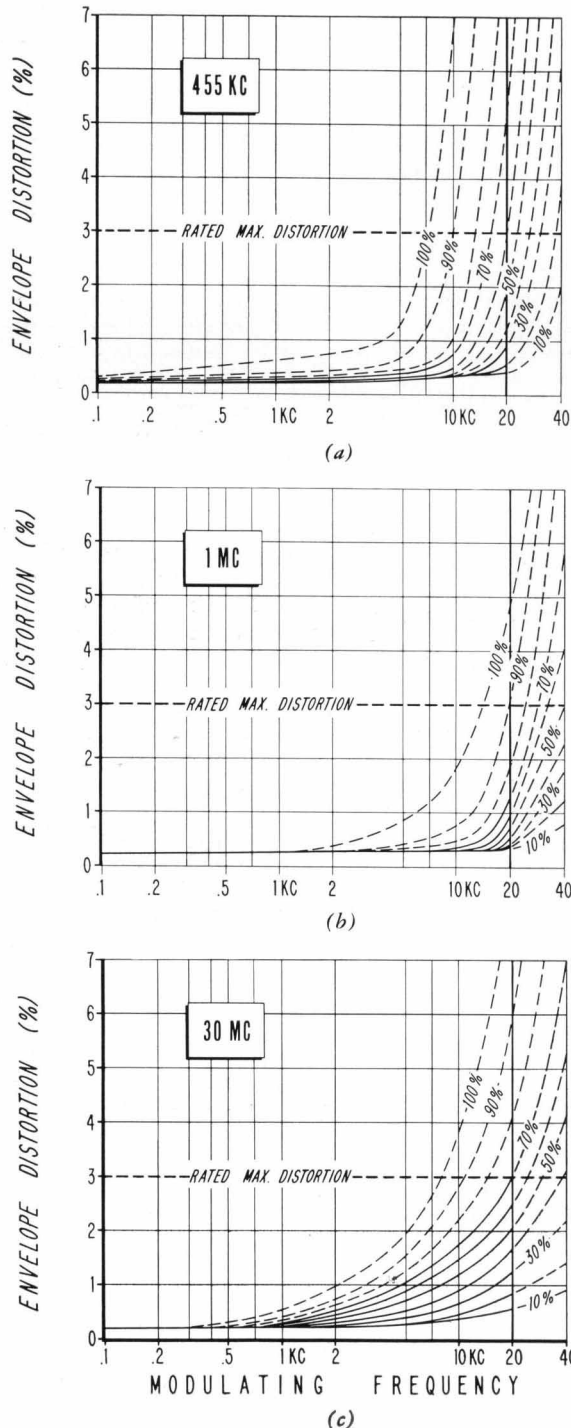
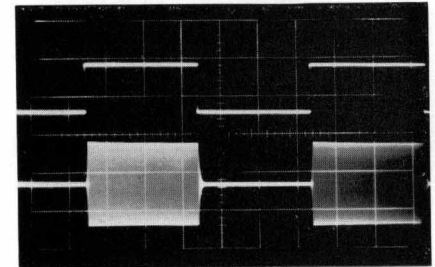
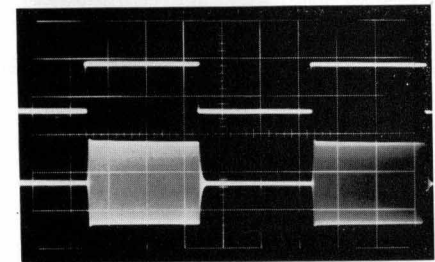

Fig. 7. Typical envelope distortion characteristics at carriers of 455 kc, 1 mc, and 30 mc. At 30% standard test level for receivers, distortion is below 1% for modulating frequencies up to 20 kc, permitting comprehensive testing of high-fidelity receivers.



(a)



(b)

Fig. 8. Oscillograms made of two carriers in standard broadcast band as modulated by 1 kc square wave. Modulating waveform is upper trace in each oscillogram.

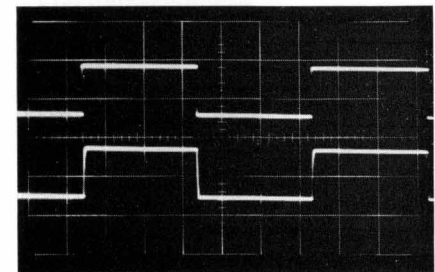

Fig. 9. Oscillogram comparing detected rf output at 60 mc with modulating 1 kc square wave (upper trace).

pulse width is 50 microseconds. Rise time is less than 10 microseconds and no overshoot is observable or typically occurs on the higher-frequency bands.

Lastly, Fig. 11 demonstrates the modulating fidelity for "complex-wave" modulation. The modulating waveform has been located just above the rf envelope for comparison purposes. The carrier frequency is 1 megacycle and the modulating waveform is about 500 cps. The oscillogram is of interest in that it shows complete turn-off of the carrier just following the main envelope. The turnoff occurs when the modulating

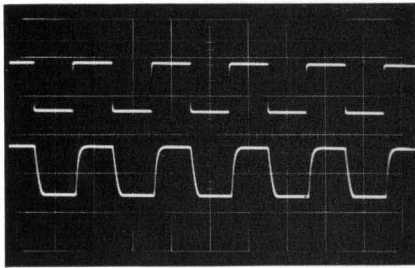

Fig. 10. Oscilloscope showing typical carrier rise and decay times at 60 mc. Pulse width is 50 microseconds; modulation rise time is less than 10 microseconds. Modulating waveform shown in upper trace.

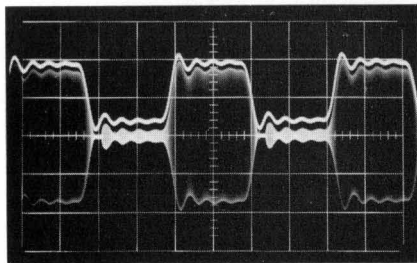

Fig. 11. Typical response to complex-wave modulation at carrier of 1 mc compared with modulating waveform (positioned closely above rf envelope).

voltage goes negative, although in this illustration the position of the waveform does not have a true relation to zero since it has been positioned above the envelope for comparison purposes.

While the generator has a nominal modulating bandwidth of 20 kc, the slow roll-off usually makes it possible to modulate with considerably higher frequencies. Fig. 12, for example, shows a carrier of 1 megacycle which has been modulated with 60 kc, although distortion here is large enough to be easily apparent.

Owing to the larger detector load capacitance needed at the lower carrier frequencies, a decrease occurs in the ac/dc impedance ratio of the detector load in the feedback loop. This factor becomes significant when the modulating frequency or modulation percentage is high, since negative peak clipping results. If it occurs, such clipping would introduce distortion in the feedback signal and thus in the rf envelope. Consequently, the generator is rated as being capable of 30% modulation for modulating frequencies that are less than 6% of the carrier and of 70% modulation by frequencies that are less than 2% of the carrier. For convenience, Fig. 14 shows these ratings in graph form. It will be seen that reduced modulation capabilities occur only at carriers lower than 1 megacycle.

## OUTPUT SYSTEM

Since the rf amplifier is operated within a loop providing a large amount of voltage feedback, the output impedance of the amplifier is virtually zero. A flat 50-ohm output impedance has thus been obtained merely by inserting a 50-ohm resistance in series with the amplifier output (Fig. 3). This resistance is followed by a 50-ohm attenuator which provides from 0 to 120 db of attenuation in 10 db steps.

The attenuator adjusts the generator output over a basic range from 1 microvolt to 1 volt (across a 50-ohm external load). An additional 15 db or so of output control is provided in the form of a continuously variable control which,

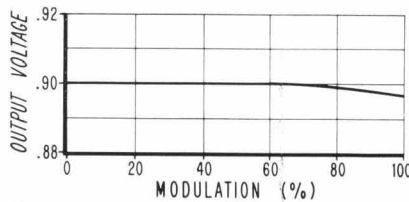

Fig. 13. Typical accuracy of percent modulation meter.

circuitwise, adjusts the bias on the modulator tube and varies the rf output level by varying the current available to the rf amplifier. This control in combination with the step attenuator is capable of reducing the rf output level to below 0.1 microvolt. If desired, this low level can be further reduced to 0.01 microvolt by a special output unit described later.

On the highest output range, a switch position integral with the step attenuator control reduces the feedback around the rf amplifier by 10 db to increase the available output from 1 volt to 3 volts across rated load. The overall output system is direct reading in voltage (3 volts to 0.1 microvolt) and in dbm (+23 to -120).

The 120 db output attenuator is essentially free of frequency effects, since it has been designed to operate to above 500 megacycles with small frequency

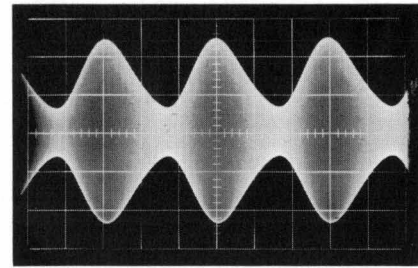

Fig. 12. Nominal bandwidth of modulation system is 20 kc but higher modulating frequencies can usually be used satisfactorily. Oscilloscope shows 1 mc carrier modulated by 60 kc.

effect.\* By itself it provides a relative output accuracy of within  $\pm 1/2$  db over the generator's full range, although an additional  $1/2$  db is added thereto for other factors. Output VSWR is less than 1.1 over the full range for outputs below 0.3 volt, increasing to a possible 1.2 at full output at the highest frequency. The output is brought out to the panel through a BNC type panel jack.

## CRYSTAL CALIBRATOR

One of the requisites for a signal generator of modern design in this range is certainly a crystal calibrator, and an unusually convenient one has been incorporated. It is arranged so that for the lower carrier frequencies a 100 kc calibrator can be used while at the higher frequencies a 1-megacycle calibrator can be used. The 100 kc calibrator can be used to at least 6 megacycles and typically to about 15 megacycles. The calibrator is crystal-controlled to an accuracy of within  $\pm 0.01\%$ .

## DUMMY ANTENNA

A standard IRE dummy antenna has also been designed for the generator in the form indicated in Figs. 15 and 16. The switch on the network either provides a direct path to the generator output connector or brings the generator output through a 10:1 voltage divider in which the dummy antenna may be switched in or out. The signal through

\* Arthur Fong and Harley L. Halverson, *Two High-Performance Attenuators for the DC-500 MC Range*, Hewlett-Packard Journal, Vol. 10, 1-2, Sept. Oct., 1958.

Fig. 14. Modulation bandwidth derating curve for use with low carrier frequencies.

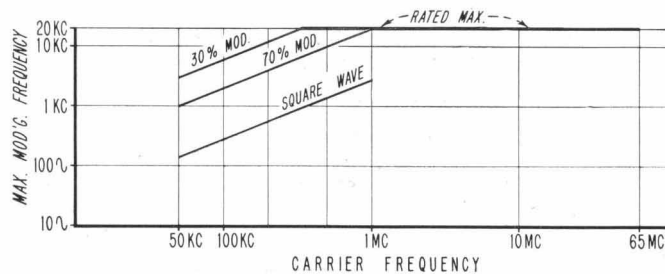

## SIGNAL GENERATOR (cont'd)

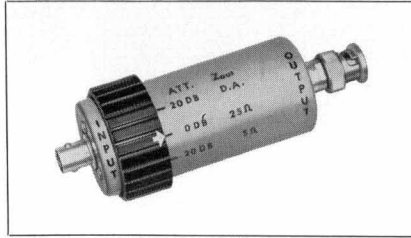

Fig. 15. Model 606A-34 Output Termination incorporates standard dummy antenna and 10:1 voltage divider.

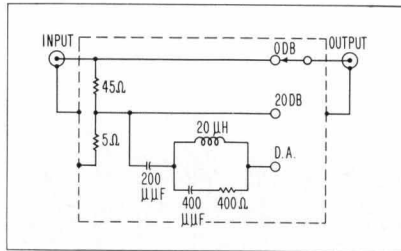

Fig. 16. Network incorporated in output termination. Outputs as low as 0.01 microvolt can be obtained.

the divider is thus 20 db below that at the output terminal, providing outputs as small as 0.01 microvolt either into the dummy antenna or from a source impedance of 5 ohms.

### DESIGN GROUP

The electrical design group for the new signal generator included Hans Asper, Johan Blokker, Harley L. Halverson, Edgar C. Hurd, Jr., Wallace A. Klingman, and Fred Meyers, while the mechanical designs were carried out by Lawrence LaBarre.

—Arthur Fong

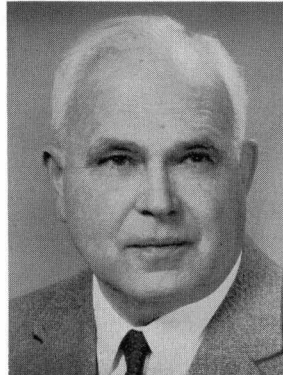

### FRIIS BECOMES CONSULTANT

Dr. Harold T. Friis has recently become affiliated with the Hewlett-Packard Company in the capacity of consultant to the -hp- laboratories. Dr. Friis is known to all radio engineers as the originator of many contributions to the radio art, having been responsible for such advances as the design of the first commercial superheterodyne receiver, the discovery of Johnson noise at radio frequencies and the concept of noise figure with subsequent improvements in receiver performance which were instrumental in the discovery of interstellar radiation by Jansky, the design of the MUSA antenna and of the rocking-horse scanning antenna, the design of the TD-X microwave relay system, and for a number of other basic achievements.

Until his retirement last year, Dr. Friis was director of research in high frequency and electronics at the Bell Telephone Laboratories.



### GAITHER ELECTED TO -hp- BOARD OF DIRECTORS

At a recent stockholders' meeting H. Rowan Gaither, Jr., was elected to the -hp- Board of Directors. Mr. Gaither was the first president of the Ford Foundation and has until recently been chairman of the Foundation's Board of Trustees. He continues as a Foundation Board member. He was also chairman of the Security Resources Panel which prepared the nationally known "Gaither Report."

Although a lawyer and banker by profession, Mr. Gaither is also well acquainted with the technical field, having been assistant director of the Radiation Laboratory at M.I.T. during the war years as well as one of the organizers and presently chairman of the Board of Trustees of the Rand Corporation.

Re-elected to the -hp- Board at the meeting were Dr. Luis W. Alvarez, Charles R. Blyth, Harold H. Buttner, and Dr. Frederick E. Terman. Also re-elected were -hp- President David Packard, -hp- Executive Vice-President William R. Hewlett, and -hp- Finance Vice-President W. F. Cavier.

### SPECIFICATIONS -hp- MODEL 606A SIGNAL GENERATOR

**Frequency Range:** 50 kc to 65 mc in 6 bands—50-170 kc; 165-560 kc; 530-1800 kc; 1.76-6.0 mc; 5.8-19.2 mc; 19.0-65.0 mc.

**Frequency Accuracy:** Within  $\pm 1\%$ .

**Frequency Calibrator:** Crystal oscillator provides check points at 100 kc and 1 mc intervals accurate within  $\pm 0.01\%$  from 0° to 50° C.

**Rf Output Level:** Continuously adjustable from 0.1  $\mu$ v to 3 volts into a 50-ohm resistive load. Calibration is in volts and dbm (0 dbm is 1 milliwatt).

**Output Accuracy:** Within  $\pm 1$  db into 50-ohm resistive load.

**Frequency Response:** Within  $\pm 1$  db into 50-ohm resistive load over entire frequency range at any output level setting.

**Output Impedance:** 50 ohms, swr less than 1.1 on 0.3 volt range and below; on 1v and 3v ranges, less than 1.1 to 20 mc and 1.2 to 65 mc. BNC Output connector mates with UG-88A/B/C/D.

**Spurious Harmonic Output:** Less than 3%.

**Leakage:** Negligible; permits receiver sensitivity measurements down to at least 0.1 microvolt.

**Amplitude Modulation:** Continuously adjustable from 0 to 100%. Indicated by a panel meter. Modulation level is constant within  $\pm 1/2$  db regardless of carrier frequency and output level changes.

**Internal Modulation:** 0 to 100% sinusoidal modulation at 400 cps  $\pm 5\%$  or 1000 cps  $\pm 5\%$ .

**Modulation Bandwidth:** Dc to 20 kc maximum, depends on carrier frequency, fc, and percent modulation as follows:

Maximum Modulation Frequency: 30% Mod., 0.06 fc; 70% Mod., 0.02 fc; Squarewave Mod., 0.003 fc (3 kc max.)

**External Modulation:** 0 to 100% sinusoidal modulation dc to 20 kc. 4.5 volts peak produces 100% modulation at modulating frequencies from dc to 20 kc. Input impedance is 600 ohms. May also be modulated by squarewaves and other complex signals.

**Envelope Distortion:** At output levels of 1 volt or less, less than 1% at 30% modulation us-

ing internal 400/1000 cps source, less than 3% from 0 to 70% modulation.

**Modulation Meter Accuracy:** Within  $\pm 5\%$  from 0 to 90%.

**Incidental FM:** At 1v or less output and 30% amplitude modulation: 0.0025% or 100 cps, whichever is greater.

**Spurious AM:** Hum and noise sidebands are 70 db below carrier down to thermal level of 50-ohm output system.

**Power:** 115/230 volts  $\pm 10\%$ , 50 to 1000 cps, approx. 135 watts.

**Size:** Cabinet Mount: 20 1/2" wide, 12 1/2" high, 14 3/4" deep. Rack Mount: 19" wide, 10 1/2" high, 13 1/2" deep behind panel.

**Weight:** Cabinet Mount: Net 46 lbs. Shipping 66 lbs. Rack Mount: Net 43 lbs. Shipping 65 lbs.

**Accessories Available:** -hp- 606A-34 Output Termination: \$50.00.

**Price:** -hp- Model 606A High Frequency Signal Generator, Cabinet Mount: \$1200.00. Rack Mount: \$1185.00.

Prices f.o.b. Palo Alto, California

Data subject to change without notice